



UPS2



UPS2 /8 m



UPS2 /4-5-6 m



BG: Предупреждение

Този продукт може да се използва от деца на 8 и повече години и лица с физически, сетивни или умствени увреждания или липса на опит и познания за продукта, ако са под надзор или са ясно инструктирани за безопасно използване на продукта. Такива лица трябва също да са наясно с опасностите, произтичащи от използването на продукта. Никога не допускайте деца да си играят с продукта. Почистването и поддръжката от потребителя не трябва да

се извършват от деца или лица с понижени физически, сетивни или умствени способности без съответен надзор.

GR: Προειδοποίηση

Αυτό το προϊόν μπορεί να χρησιμοποιηθεί από παιδιά ηλικίας 8 ετών και πάνω, καθώς και από άτομα με μειωμένες σωματικές, αισθητηριακές ή πνευματικές ικανότητες ή χωρίς την ανάλογη εμπειρία και γνώση του προϊόντος, με την προϋπόθεση ότι βρίσκονται υπό την επίβλεψη άλλου ατόμου ή ότι έχουν λάβει σαφείς οδηγίες σχετικά με την ασφαλή χρήση

του προϊόντος. Τα άτομα αυτά θα πρέπει επίσης να κατανοούν τους κινδύνους που ενέχει η χρήση του προϊόντος. Ποτέ μην επιτρέψετε σε παιδιά να παίξουν με το προϊόν.

RO: Avertizare

Acest produs poate fi utilizat de copiii cu vârsta de cel puțin 8 ani precum și de persoanele cu capacități fizice, senzoriale sau mentale reduse sau care nu au experiență cu, și cunoștințe despre produs, cu condiția de a fi sub supraveghere sau de a li se da instrucțiuni clare pentru utilizarea produsului în condiții de siguranță. Aceste persoane trebuie de asemenea să înțeleagă pericolele

implicate de utilizarea produsului. Nu permiteți niciodată copiilor să se joace cu produsul. Curățarea și întreținerea de către utilizator nu trebuie efectuate de copii sau persoane cu capacități fizice, senzoriale sau mentale reduse fără o supraveghere corespunzătoare.

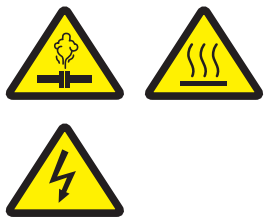

Max. 95 % RH
IP44

UPS2
4-5-6-8 m



Min./Max.
+2 °C / +95 °C



Max. 1.0 MPa
(10 bar)



Min./Max.
0 °C / +40 °C



< 43 dB(A)



UPS2
4-5-6-8 m





UPS2
4-5-6-8 m

Max.	°C	°C
40	40 - 95	40 - 95
30	30 - 95	30 - 95
20	20 - 95	20 - 95
Min. 0	2 - 95	2 - 95

GRUNDFOS
Type: UPS2 P/N: PC: 1251
230V - 50/60 Hz IP: 44
I (A) | P (W) Max. | Min. Max. 1.0 MPa
0.42 | 48 Max. TF 95
0.06 | 7 Min. EEI s 0.23 - Part 2

1

UPS2
4-5-6-8 m

UPS2
4-5-6-8 m



UPS2
4-5-6-8 m



UPS2
4-5-6-8 m

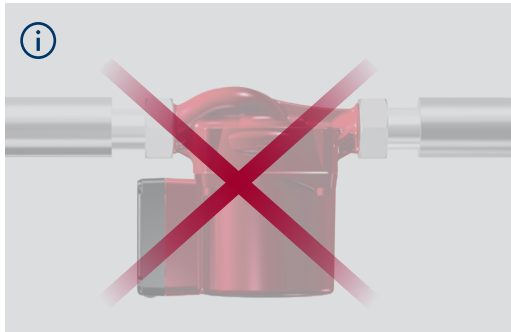
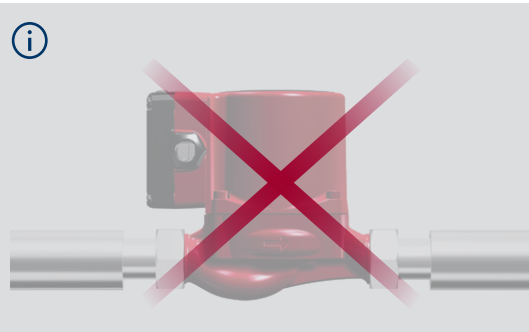



2

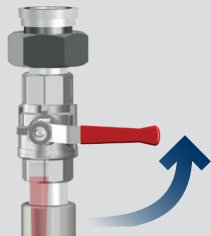
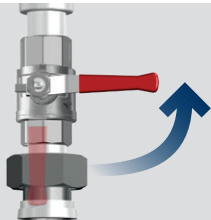

3

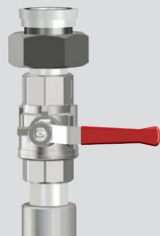

UPS2
4-5-6-8 m

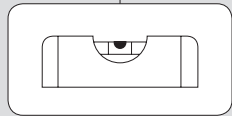
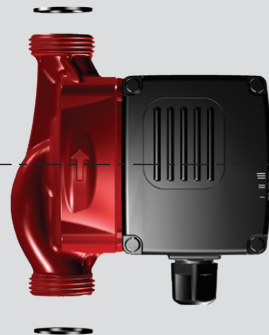

4





5

UPS2
4-5-6-8 m

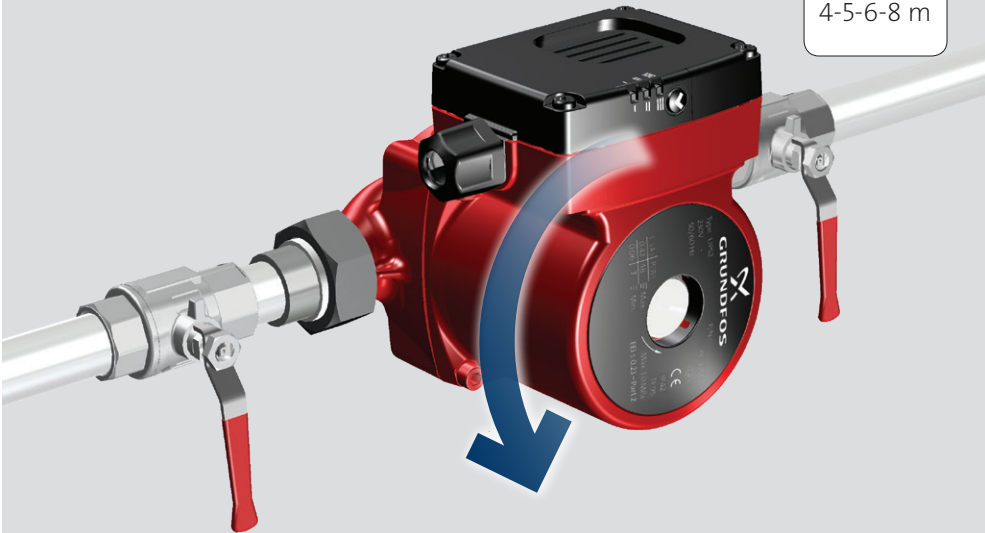

6



UPS2
4-5-6-8 m

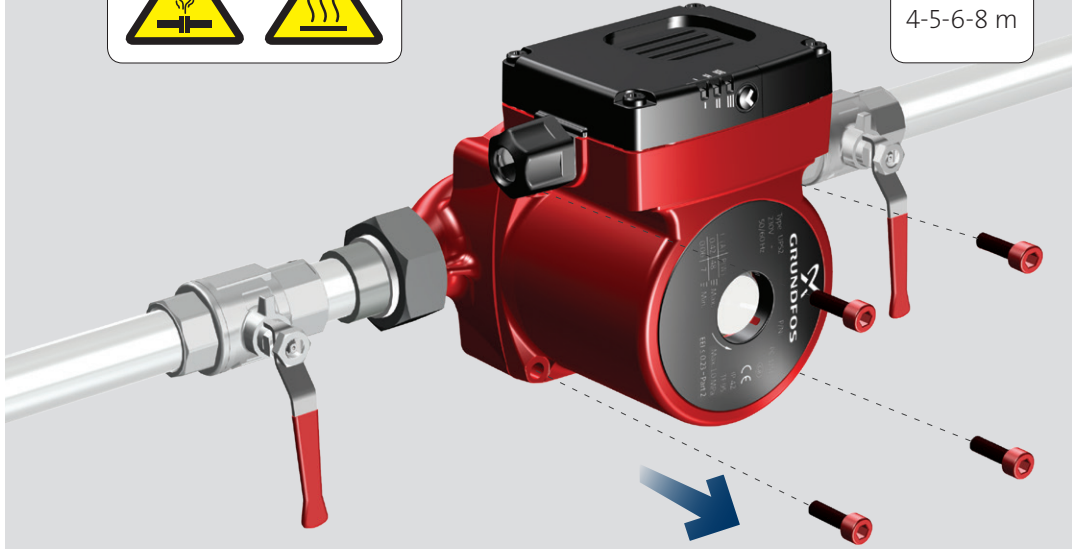



7



UPS2
4-5-6-8 m

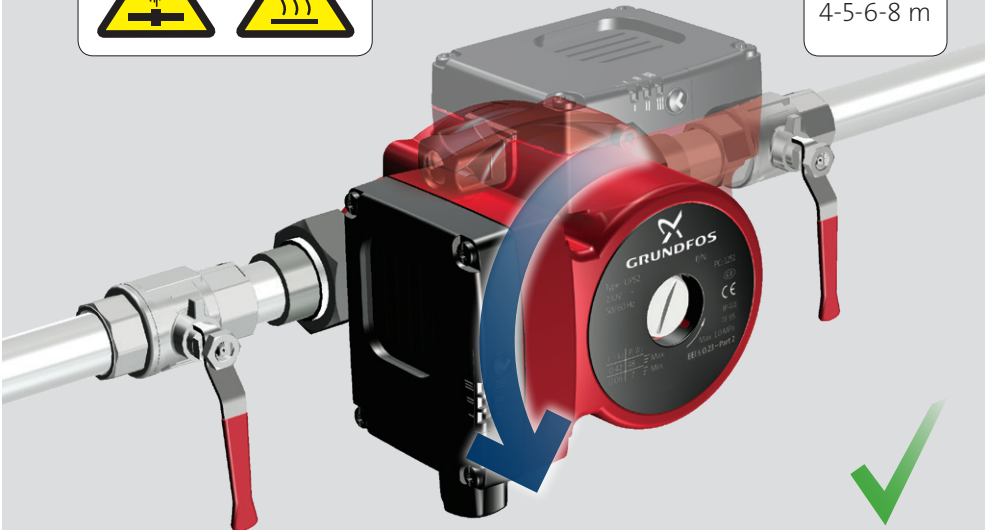

8



UPS2
4-5-6-8 m





9a



UPS2
4-5-6 m



10a

UPS2
4-5-6 m

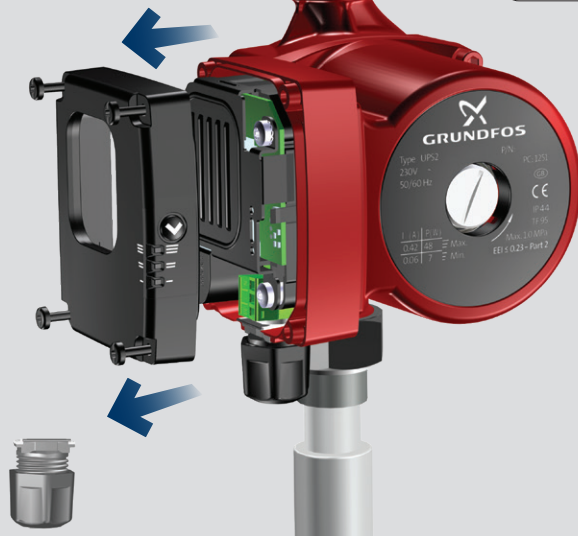

11a

UPS2
4-5-6 m





12a

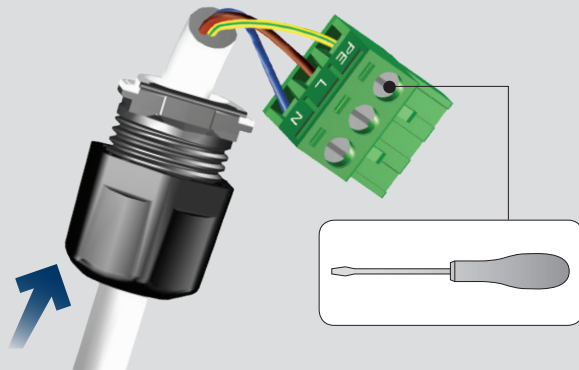
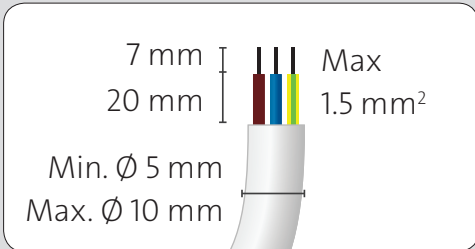

13a



UPS2
4-5-6 m



14a

UPS2
4-5-6 m





15a

UPS2
4-5-6 m

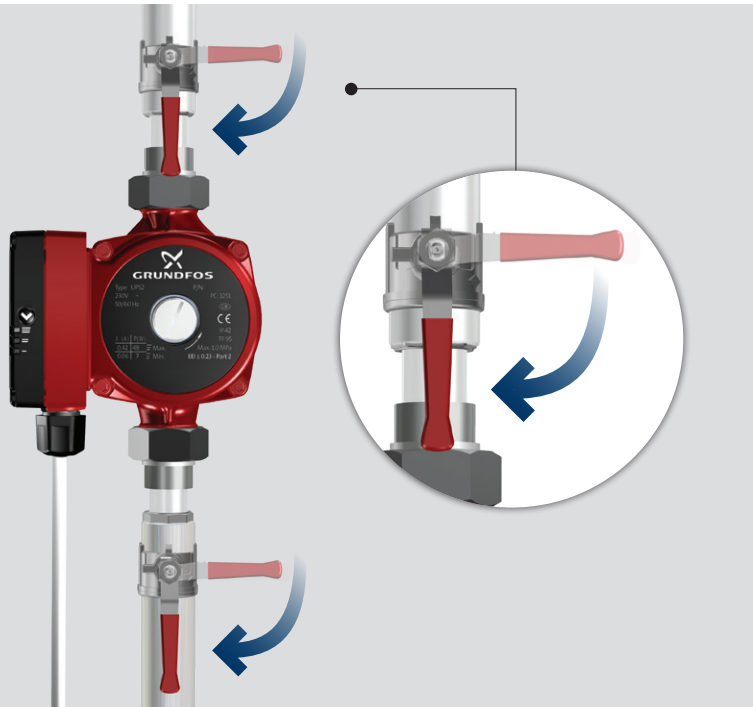

16a

1x 230 V ± 10 %
~ 50/60 Hz ⚡



RCD TYPE A 

17a

UPS2
4-5-6 m



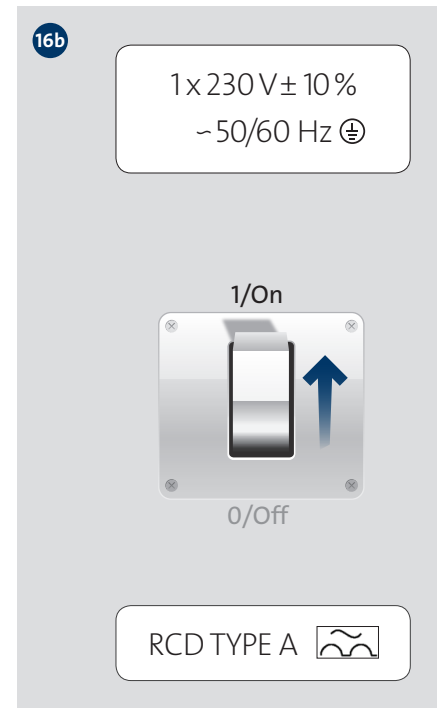
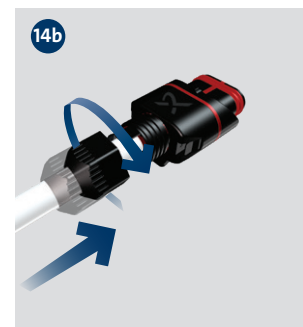
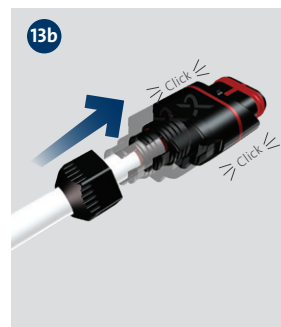
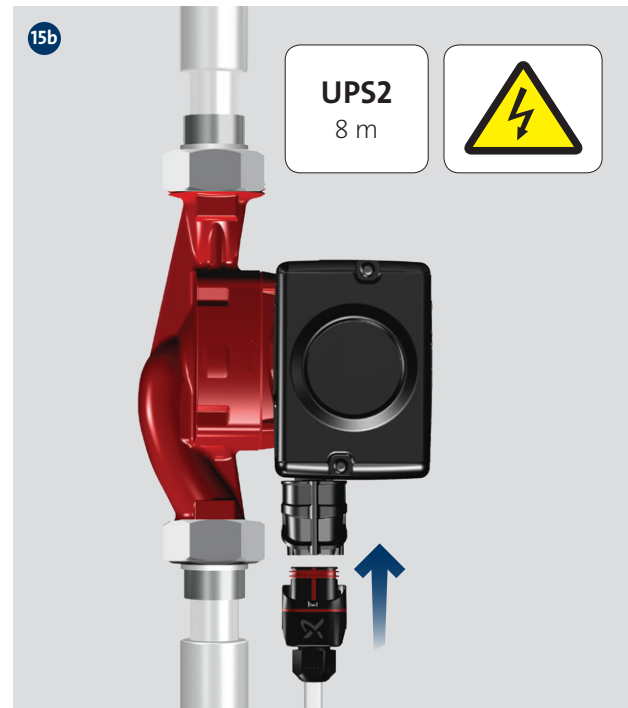
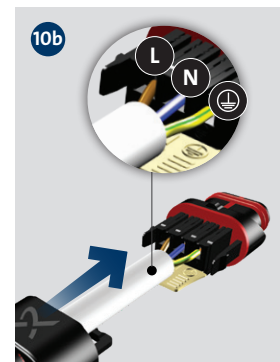
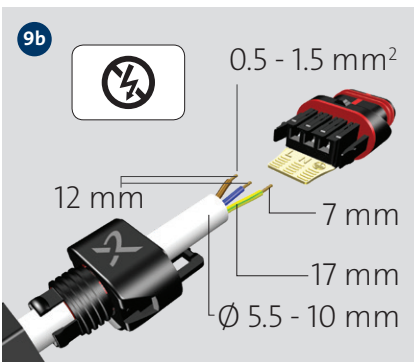



i

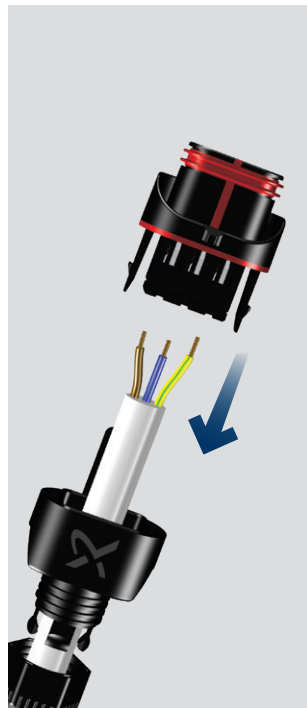
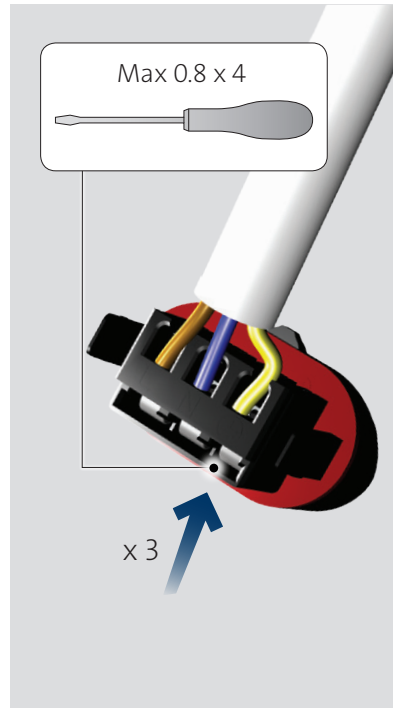
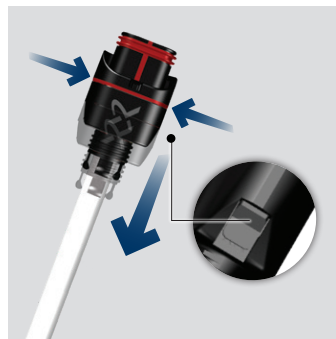
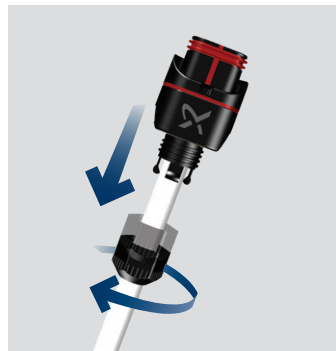
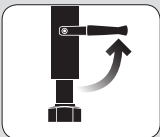



UPS2
4-5-6 m

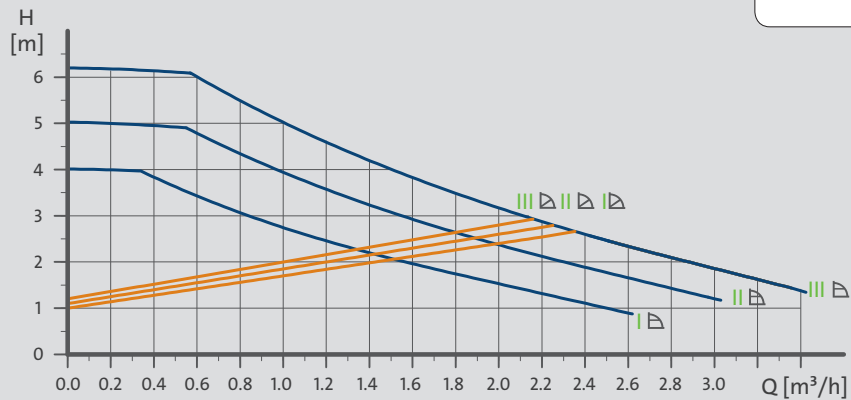

UPS2
8 m

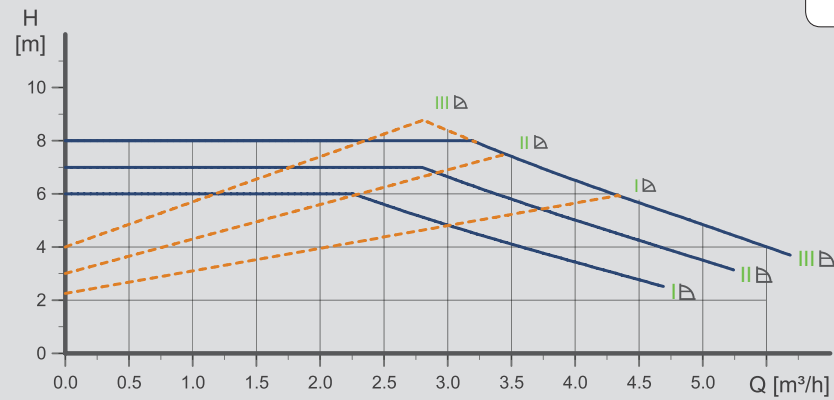



■ = III / II / I
■ = ▢III / ▢II / ▢I

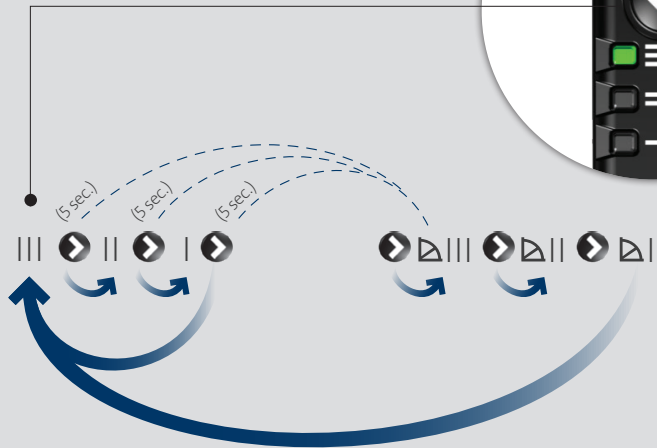

UPS2
4-5-6 m

 ■ = III / II / I

 ■ = III / II / I

 ■ = ▢III / ▢II / ▢I



Hold 3 sec.

1 click
PP

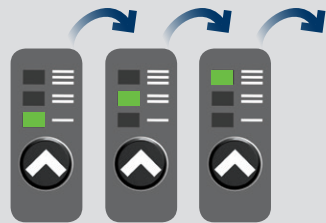

1 click
CP

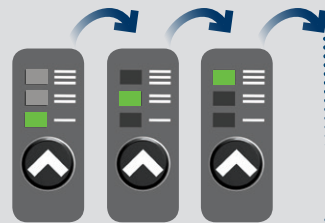

UPS2
8 m



GRUNDFOS
Type: UPS2 P/N: PC-1438
230V ~
50/60 Hz
I (A) | P (W)
1.10 | 140 Max.
0.10 | 11 Min.
Max. 1.0 MPa
EEL s 0.23 - Part 2



Conversion table

CURRENT PUMP	SPEED SETTING ON OLD UPS BEING REPLACED	EQUIVALENT SETTING ON NEW UPS2
4 m.	All settings: I-II-III	I
5 m.	I	I
	II	II
	III	II
6 m.	I	I
	II	II
	III	III
8 m.	I	I
	II	II
	III	III

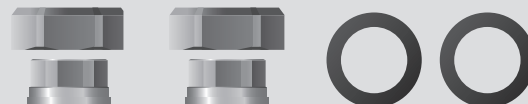

Product No		
25*-XX (A)	3/4"	529921
25*-XX (A)	1"	529922
32-XX	1"	509921
32-XX	1 1/4"	509922

*= 15 for UK version

UPS2 8 m



Product No	
15-XX	98284561
25-XX	
32-XX	



Product No	
15-XX	98610291
25-XX	
32-XX	



BG: Зачеркнатият символ на кофа за отпадъци върху продукта означава, че той трябва да бъде изхвърлен отделно от битовите отпадъци.

Когато маркираният с този символ продукт достигне края на експлоатационния си живот, отнесете го в пункт за събиране на такива отпадъци, посочен от местните организации за третиране на отпадъци. Разделното събиране и рециклиране на подобни продукти ще спомогне за опазването на околната среда и здравето на хората.

GR: Το σύμβολο με τον διαγραμμένο κάδο απορριμμάτων σημαίνει ότι πρέπει να απορριφθεί ξεχωριστά από τα οικιακά απορρίμματα. Όταν ένα προϊόν που φέρει αυτό το σύμβολο φτάσει στο τέλος της διάρκειας ζωής του, παραδώστε το σε ένα σημείο συλλογής το οποίο καθορίζεται από τις τοπικές αρχές διάθεσης απορριμμάτων. Η ξεχωριστή συλλογή και ανακύκλωση τέτοιων προϊόντων θα βοηθήσει στην προστασία του περιβάλλοντος και της ανθρώπινης υγείας.

RO: Simbolul de pebelă întretăiată aflată pe un produs denotă faptul că acesta trebuie depus la deșeurii separat de gunoii menajer. Când un produs cu acest simbol ajunge la sfârșitul duratei de viață, acesta trebuie dus la un punct de colectare desemnat de către autoritățile locale de administrare a deșeurilor. Colectarea și reciclarea separate ale acestor produse vor ajuta la protejarea mediului înconjurător și a sănătății umane.

BG: Декларация за съответствие на ЕО

Ние, фирма Grundfos, заявяваме с пълна отговорност, че продуктът UPS2, за който се отнася настоящата декларация, отговаря на следните директиви на Съвета за уеднаквяване на правните разпоредби на държавите-членки на ЕО.

GR: Δήλωση συμμόρφωσης ΕΕ

Εμείς, η Grundfos, δηλώνουμε με αποκλειστικά δική μας ευθύνη ότι το προϊόν UPS2, στο οποίο αναφέρεται η παρακάτω δήλωση, συμμορφώνεται με τις παρακάτω Οδηγίες του Συμβουλίου περί προσέγγισης των νομοθεσιών των κρατών μελών της ΕΕ.

RO: Declarația de conformitate UE

Noi Grundfos declarăm pe propria răspundere că produsul UPS2, la care se referă această declarație, este în conformitate cu Directivele de Consiliu specificate mai jos privind armonizarea legilor statelor membre UE.

Low Voltage Directive (2014/35/EU)

Standards used:

- EN 60335-1:2012/A11:2014/A12:2017/A13:2017
- EN 60335-2-51:2003/A1:2008/A2:2012
- EN62233:2008

EMC Directive (2014/30/EU)

Standards used:

- EN 55014-1:2006/A1:2009/A2:2011
- EN 55014-2:2015
- EN61000-3-2:2014
- EN61000-3-3:2013

Ecodesign Directive (2009/125/EC)

Commission Regulation (EC) No 641/2009

Commission Regulation (EC) No 622/2012

Standards used:

- EN 16297-1:2012
- EN 16297-2:2012

RoHS Directives: 2011/65/EU and 2015/863/EU

Standard used:

- EN 50581:2012

Bjerringbro, 19th of December 2018

Frank Skovgaard
Senior Manager
Grundfos Holding A/S
Poul Due Jensens Vej 7
8850 Bjerringbro, Denmark

This EC declaration of conformity is only valid when published and distributed as part of the Grundfos installation and operating instructions.

Installation date: _____

Installer:

98676376 0119

ECM: 1251868

be think innovate

GRUNDFOS 

Trademarks displayed in this material, including but not limited to Grundfos, the Grundfos logo and "be think innovate" are registered trademarks owned by The Grundfos Group. All rights reserved.

© 2018 Grundfos Holding A/S, all rights reserved.